

CRS-1000

1000W SINGLE OUTPUT DC/DC CONVERTERS

GENERAL FEATURES:

- Designed according to EN50155
- Fire and smoke: EN45545-2 approved
- High input-output isolation
- Adjustable output voltage
- Remote inhibit
- Remote sensing
- Input & Output OK LEDs
- Output failure alarm
- Input reverse polarity protection
- ORing FET option
- Different cooling options
- Efficiency up to 94%



	24Vin 14,4V ... 30V	36Vin 21,6V ... 47V	48Vin 28,8V ... 60V	72Vin 43,2V ... 90V	110Vin 66V ... 144V
24Vout	CRS-1000-6475	CRS-1000-6487	CRS-1000-6478	CRS-1000-6481	CRS-1000-6484
48Vout	CRS-1000-6476	CRS-1000-6488	CRS-1000-6479	CRS-1000-6482	CRS-1000-6485
72Vout	CRS-1000-6490	CRS-1000-6491	-	-	-
110Vout	CRS-1000-6492	-	-	-	CRS-1000-6493



INPUT

Input voltage range	See table
Input undervoltage shutdown	55% to 60% V_i nom
Maximum allowed input ripple	15% V_{in} nom (EN50155)

OUTPUT

Output voltage	See table
Output voltage adjustment	
V_i min = 60% V_i nom	-10% ... +0% V_o nom
V_i min = 70% V_i nom	-10% ... +15% V_o nom
Line regulation (I_o = nom)	< 0,2 %
Load regulation (V_{in} = nom I_o : 0...100%)	< 0,2 %, 2,5 % for ORing FET option
Ripple	< 50 mVpp
Noise (BW = 20MHz)	< 100 mVpp
Max. overvoltage protection	< 140% V_{out} nom
Maximum remote sense	0.3V / pole

ENVIRONMENTAL

Storage temperature	-40°C ... 85°C
Operating temperature range I_o : 100%	-25°C ... 55°C (-40°C ... 55°C, see note-1)
Operating temperature range I_o : 75%	-25°C ... 70°C (-40°C ... 70°C, see note-1)
Cooling	Natural convection
Maximum Relative humidity	95% with no condensation
Shock and vibration	EN61373 Category 1 class B body mounted
MTBF (at 40°C and 75% load)	350.000h acc. to IEC61709 Cooling options R, V, D 250.000h acc. to IEC61709 Cooling option C
Service life (at 40°C and 75% load)	20 years (Option C fan maintenance at 10 years is required)

EMC

Emission	EN61000-6-4, EN50121-3-2
Immunity	EN61000-6-2, EN50121-3-2

SAFETY

Safety	EN60950 EN50155
Dielectric strength Input-Output	3000Vac, 4200Vdc 1min.
Dielectric strength Input-Earth	1500Vac, 2100Vdc 1min.
Dielectric strength Output-Earth	1500Vac, 2100Vdc 1min.
Fire and smoke	EN45545-2:2013 +A1:2015

MECHANICAL

Approximate weight	2500g
--------------------	-------

CONTROL

Remote inhibit range	Logic: 1=OFF, Range: 15 ... 143 Vdc, Impedance > 27k Ω
Alarm contacts	1A @ 24Vdc, 0.3A @ 150Vdc, 1A @ 125Vac
Local: Input OK, Output OK	Green LEDs

PROTECTIONS

Against overloads and short-circuits	Current limiting
Against output over-voltages	Shutdown (reset by input switch off)
Against over-temperature	Shutdown with self-recovery
Against reverse input voltage.	Input fuse (Active protection with option H)
Against input under-voltage.	Under-voltage lock-out
Against Input over-currents	Input fuse

Note-1: The unit can start up and work at an ambient temperature of -40°C with the following restrictions:

- 1) Do not handle the connection terminals below -25°C.
- 2) The output ripple can rise up to 150mVpp at -40°C



ORDERING CODES

Part Number	Output Power [W]	Input voltage [V]	Input voltage range [V]	Maximum Input current [A]	Output Voltage [V]	Output current [A]	Efficiency At full load [%]
CRS-1000-6475	1000	24	14,4 - 30	78,9	24	41,6	88
CRS-1000-6476	1000	24	14,4 - 30	78,0	48	20,8	89
CRS-1000-6490	1000	24	14,4 - 30	77,2	72	13,9	90
CRS-1000-6492	1000	24	14,4 - 30	77,2	110	9,8	90
CRS-1000-6487	1000	36	21,6 - 47	51,4	24	41,6	90
CRS-1000-6488	1000	36	21,6 - 47	51,4	48	20,8	90
CRS-1000-6491	1000	36	21,6 - 47	50,9	72	13,9	91
CRS-1000-6478	1000	48	28,8 - 60	38,2	24	41,6	91
CRS-1000-6479	1000	48	28,8 - 60	37,7	48	20,8	92
CRS-1000-6481	1000	72	43,2 - 90	25,4	24	41,6	91
CRS-1000-6482	1000	72	43,2 - 90	25,2	48	20,8	92
CRS-1000-6484	1000	110	66 - 144	16,5	24	41,6	92
CRS-1000-6485	1000	110	66 - 144	16,3	48	20,8	93
CRS-1000-6493	1000	110	66 - 144	16,1	110	9,8	94

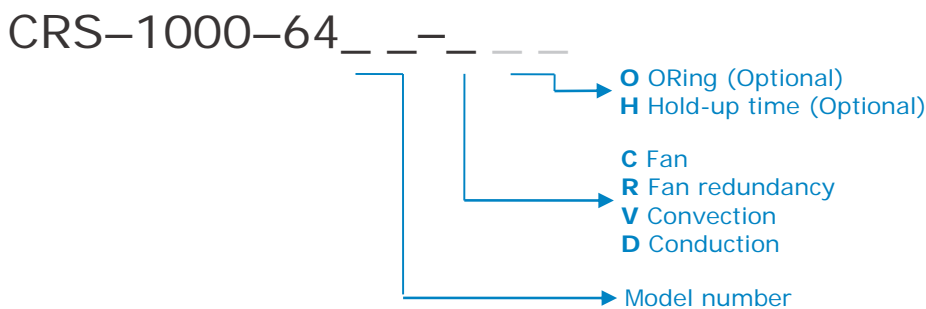

OPTIONS INFORMATION	Letter code
Fan cooling (2 fans with speed control)	C
Fan redundancy cooling (4 fans with speed control working at half speed at full load)	R
Convection cooling	V
Conduction cooling	D
Hold up time of 10ms at 1000W. Includes: <ul style="list-style-type: none"> • Active protection against input reverse polarity • Active inrush current limiter at $< 2 \cdot I_{nmax}$ (Maximum Input current) 	H
ORing FET for redundancy. Includes a passive current sharing by voltage drop $< 2.5\%$	O

Accessories must be ordered in a separate order line



Option C: Fan cooling

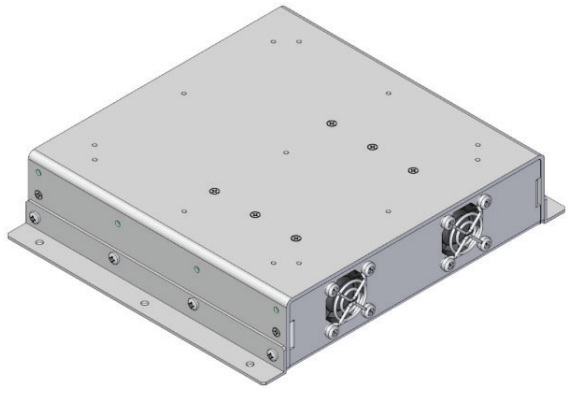
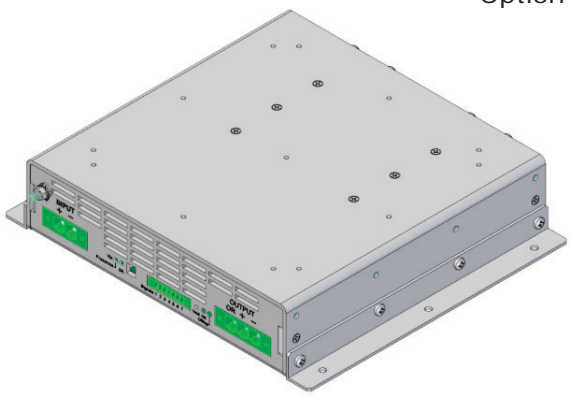

Option R: Fan redundancy cooling

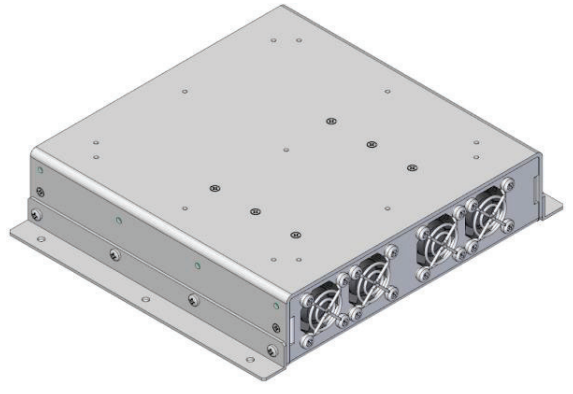
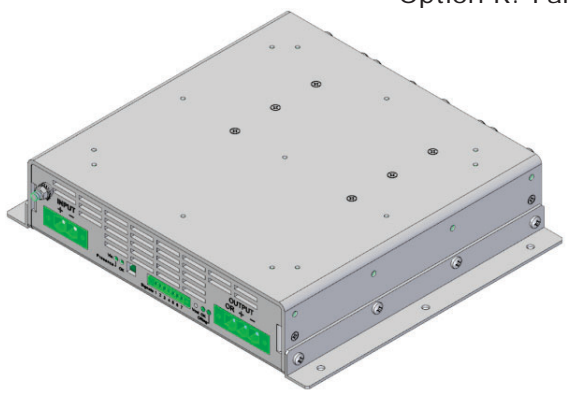

Option V: Convection cooling

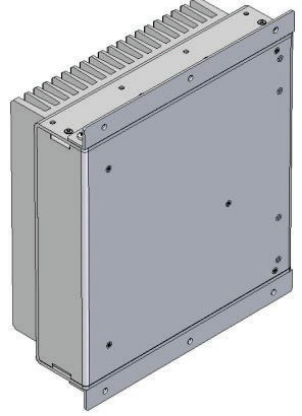
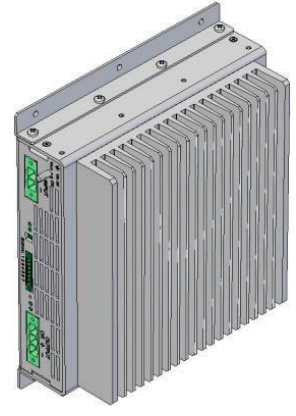
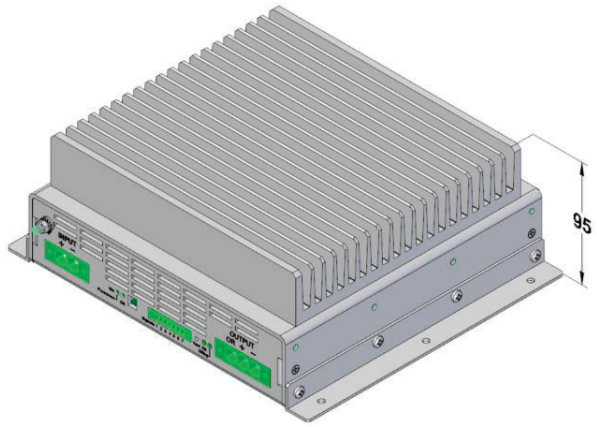

Option D: Conduction cooling

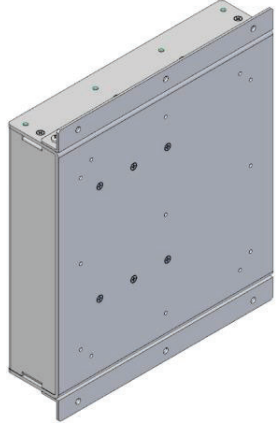
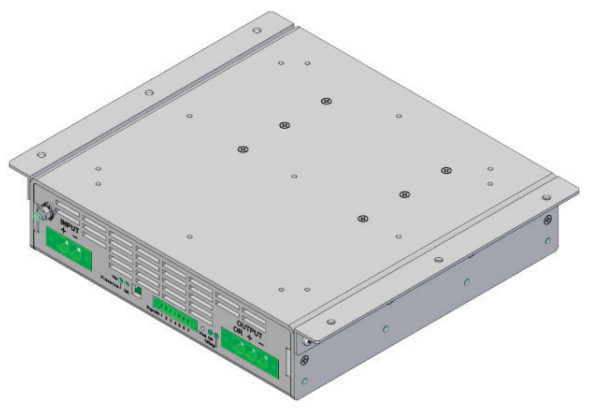



BLOCKS DIAGRAM

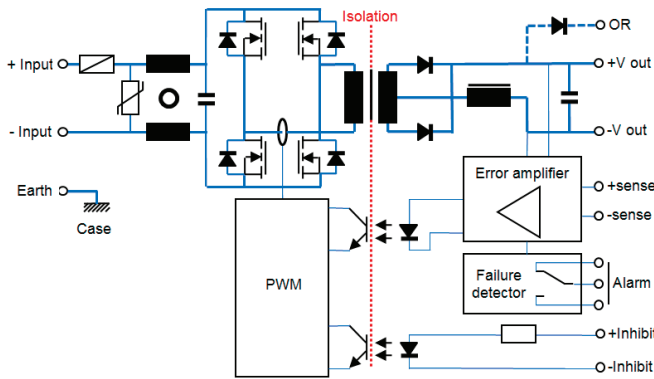

Typical output characteristic

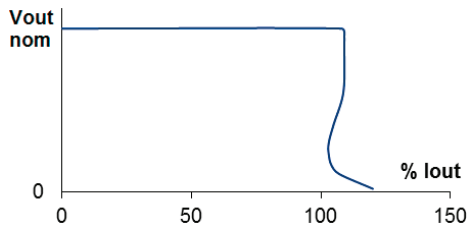

Power derating vs ambient temperature & altitude[m]

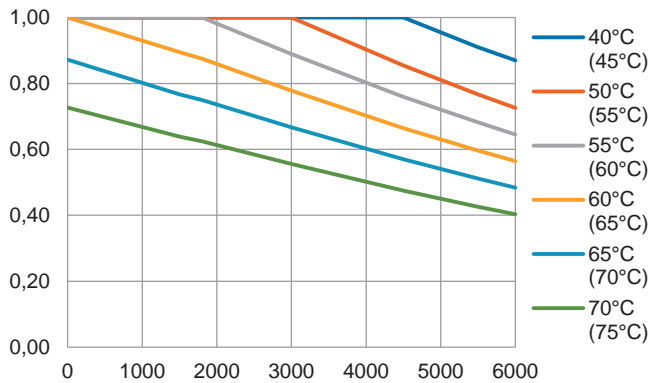

Output/Input working area

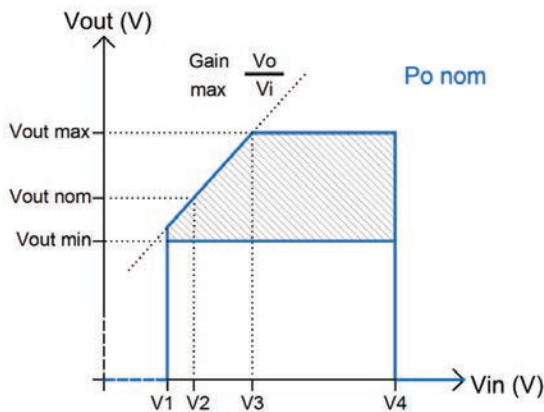

MODELS	V1	V2	V3	V4
24V input	<14.4 V	15.4 V	16.8 V	>30 V
Rest	< 0.6·Vin nom	0.6·Vin nom	0.7·Vin nom	>1.25·Vin nom

DESCRIPTION

The CRS-1000 series consists of DC-DC converters with a galvanic isolation input-output and fixed switching frequency.

For maximum regulation, the remote sensing terminals can be connected to the load. This will allow a power cable voltage drop of up to 0.3 V on each cable to be offset.

The device is protected against overloads and short-circuits by means of a current limiting circuit.

The device is also protected against reverse polarity input voltage, and the input fuse blows if an improper connection is made.

When a converter input under-voltage condition occurs, the converter is disabled, thus preventing the battery from becoming totally discharged.

INSTALLATION

The product has been designed to be installed on a chassis by means of the included mounting brackets.

With the option of natural convection, the heatsink fins must be mounted in vertical position. With the other cooling options there is no preferred mounting position.

With forced air options, the inlet and outlet air must be free of elements that cause an airflow reduction (the minimum recommended distance to other objects is 50mm).

It is necessary to take into account the environmental conditions of maximum temperature and altitude, since they can limit the maximum output power. See the figure "Power derating vs ambient temperature & altitude". If you have the option "R" (4 fans), the temperature values in brackets can be used. In this case the redundancy of ventilation is lost.

START-UP

Perform connection according to the figure. Use of remote sensing is not mandatory, but if this is required, use of a coaxial or a twisted-pair cable is recommended.

WARNING: If the load is connected to the tabs of remote sensing (+/-S) and the connection from the output to this load is missing the remote sensing function could be lost due to the acting of the internal fuse of protection.

If several converters need to be connected in parallel, do the following:

THIELE KG
CONNECTIONS

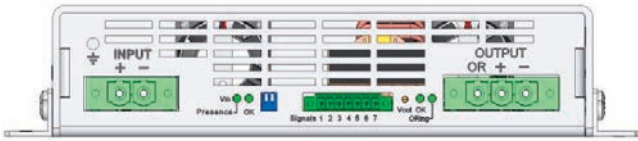

Power connections (input and output)

Input & Output: Connectors for cables up to 16mm²
 Earth M5 threaded stud

Signals connector

1	+ Inhibit
2	- Inhibit
3	- Remote sense
4	+ Remote sense
5	Alarm relay NC (closed when alarm)
6	Alarm relay Common
7	Alarm relay NO (open when alarm)

- Set the output voltage for all converters featuring a mutual difference as small as possible.
- Join the load outputs by using cables with a cross-section no greater than the one required and of equal length.
- Do not use remote sensing.

For safety reasons, the following requirements must be complied with:

- Provide the equipment with a protective enclosure that complies with the electrical safety directives in effect within the country where the equipment is installed.
- Only replace the fuse with another fuse of the same rating and type, and only after disconnecting the converter from DC power.
- In case of installing input breaker, we recommend one with a current rating higher than the maximum input current curve C. See ORDERING CODES table.
- In case of installing input fuse, we recommend one with a current rating higher than the maximum input current type T (time lag). See ORDERING CODES table.

ALARM

The alarm can be activated by the following reasons:

- When the output voltage is lower than 80...88% of Vout nom.
- When there is a defective fan. In this case the LED Vin OK blinks.
- When the internal temperature reaches about 98°C; just a few degrees below the overtemperature protection shutdown. In this case the LED Vin OK also blinks.



DIMENSIONS

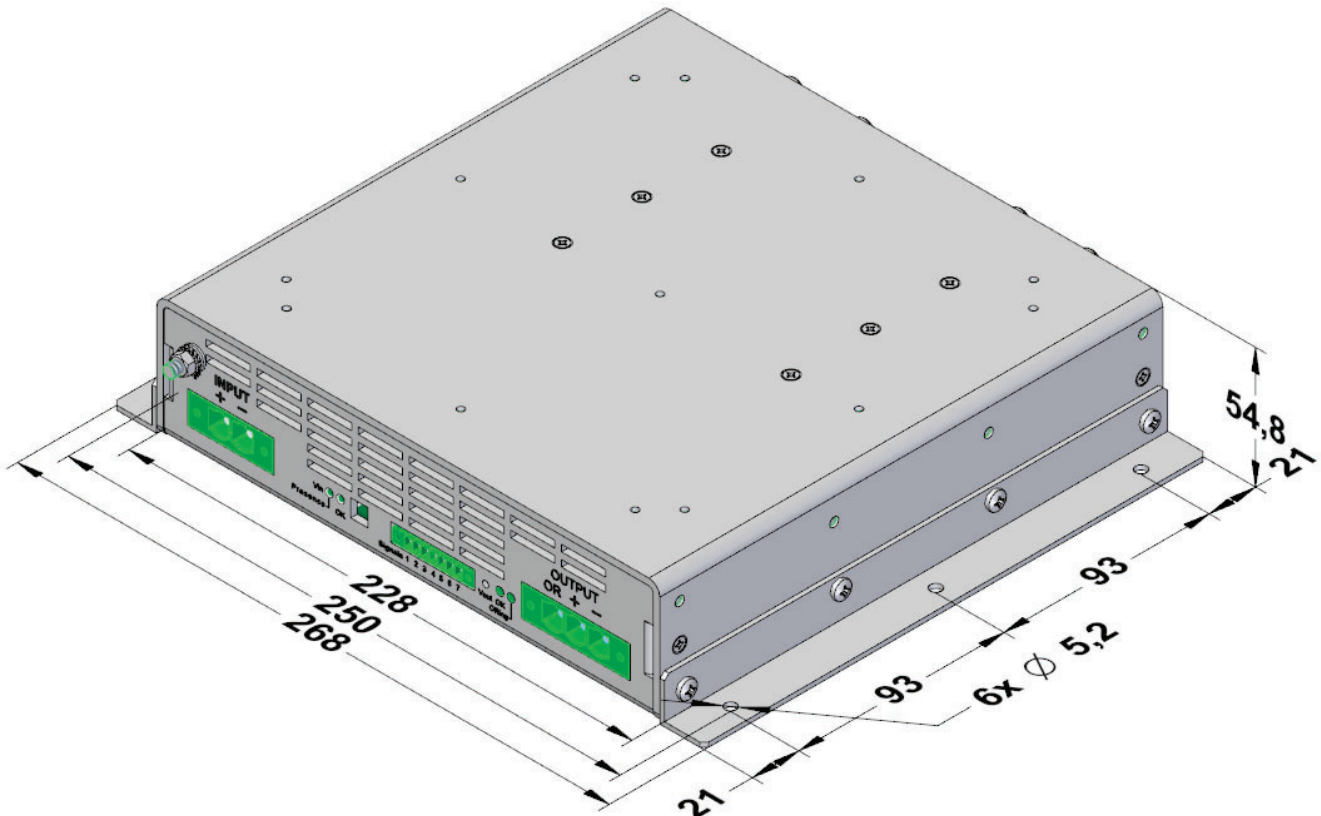

ACCESSORIES

Description	Notes	CODE
Signals mating connector	Phoenix Contact FK-MCP 1,5/ 7-STF-3,81	2601-395
Power mating connector (input)	Phoenix Contact SPC 16/ 2-STF-10,16	2601-606
Power mating connector (output)	Phoenix Contact SPC 16/ 3-STF-10,16	2601-607
Guiding plates for 6U subrack mounting	Screws included	NP-9222
Brackets for 6U subrack mounting	Screws included	NP-9352
2U 19" rackmount tray kit	Screws included	NP-9354

2601-395



2601-606

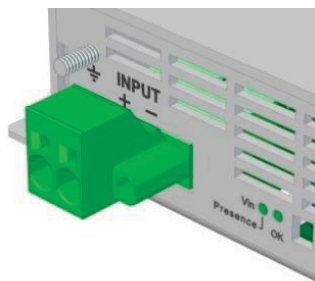

2601-607

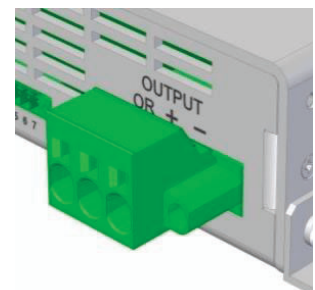



NP-9222+NP-9352

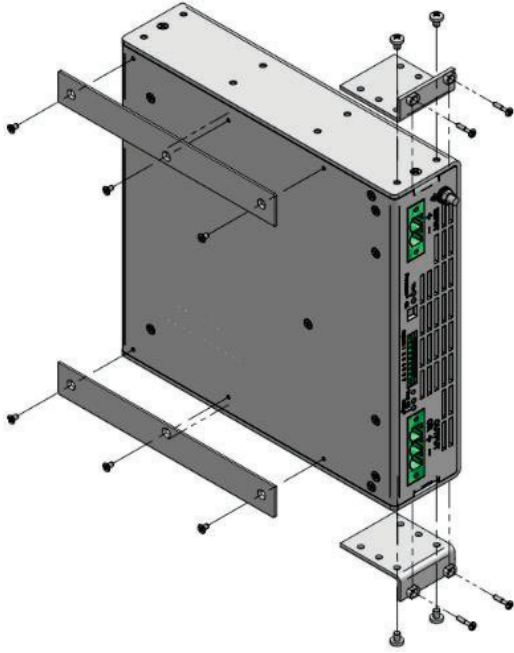

NP-9354

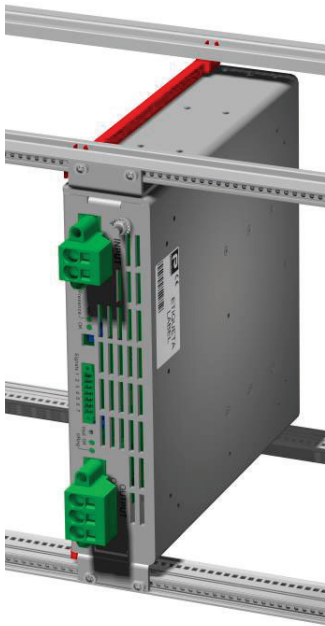
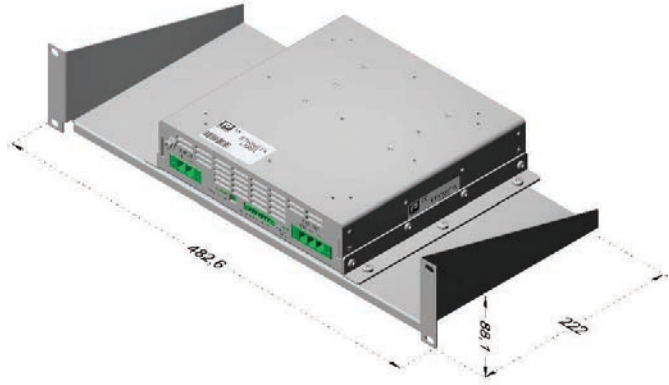



CE EU DECLARATION OF CONFORMITY

The undersigned, representing the following:

Manufacturer: PREMIUM, S. A.,
Address: C/ Dolors Aleu 19-21, 08908 L'Hospitalet de Llobregat, SPAIN

herewith declares that the product:

Type: DC/DC converter
Models: **CRS-1000-6475 ... 6493**

is in conformity with the provisions of the following EU directive(s):

2014/35/EU	Low voltage
2014/30/EU	Electromagnetic compatibility
2011/65/EU	Restriction of the use of certain hazardous substances in electrical and electronic equipment (RoHS)

and that standards and/or technical specifications referenced overleaf have been applied:

EN 60950-1: 2005	Safety. Information technology equipment
EN 62368-1: 2014	Safety. Audio/video, information and communication technology equipment
EN 61000-6-4: 2007	Generic emission standard
EN 61000-6-2: 2005	Generic immunity standard
EN 50155: 2017*	Railway applications. Electronic equipment used on rolling stock material
EN 50121-3-2: 2016* IEC 62236-3-2: 2018*	Railway applications. EMC Rolling stock equipment
EN 50121-4: 2016* IEC 62236-4: 2018*	Railway applications. EMC of the signalling and telecommunications apparatus

* See annexe

CE marking year: **2018**

Notes:

For the fulfillment of this declaration the product must be used only for the aim that has been conceived, considering the limitations established in the instructions manual or datasheet.

L'Hospitalet de Llobregat, 28-08-2019

Jordi Gazo
Chief Executive Officer

PREMIUM S.A. is an ISO9001 and ISO14001
certified company by **Bureau Veritas**



ANNEXE

Applicable values for the different sections of the norm EN50155: 2017																																																																
4.3.1	Working altitude	Up to 2000m																																																														
4.3.2	Ambient temperature	Class OT1 (-25 to 55°C): load < 100% Class OT2 (-40 to 55°C): load < 100% (Without connectors handling and output ripple <150mVpp) Class OT3 (-25 to 70°C): load < 75% Class OT4 (-40 to 70°C): load < 75% (Without Connectors handling and output ripple <150mVpp) Class OT5 (-25 to 85°C): load < 37.5% Class OT6 (-40 to 85°C): load < 37.5% (Without Connectors handling and output ripple <150mVpp)																																																														
4.3.3	Switch-on extended operating temp.	ST1																																																														
4.3.4	Rapid temperature variations	H1																																																														
4.3.5	Shocks and vibrations	According EN61373:2010 Category 1 class B																																																														
4.3.6	EMC Electromagnetic Compatibility EN 50121-3-2: 2016 IEC 62236-3-2: 2018 EN 50121-4: 2016 IEC 62236-4: 2018	<table border="1"> <thead> <tr> <th>Test</th> <th>Norm</th> <th>Port</th> <th>Frequency</th> <th>Limits</th> </tr> </thead> <tbody> <tr> <td rowspan="3">Radiated emissions</td> <td rowspan="3">IEC55016</td> <td rowspan="3">Case</td> <td>30MHz...230MHz</td> <td>40dB(µV/m) Qpk at 10m</td> </tr> <tr> <td>230MHz...1GHz</td> <td>47dB(µV/m) Qpk at 10m</td> </tr> <tr> <td>1...3GHz</td> <td>Do not apply</td> </tr> <tr> <td rowspan="2">Conducted emissions</td> <td rowspan="2">IEC55016</td> <td rowspan="2">Input</td> <td>3...6GHz</td> <td>Internal freq. < 108MHz</td> </tr> <tr> <td>150kHz...500kHz</td> <td>79dB(µV) Qpk, 66dB(µV) Av</td> </tr> <tr> <td></td> <td></td> <td></td> <td>500kHz...30MHz</td> <td>79dB(µV) Qpk, 60dB(µV) Av</td> </tr> </tbody> </table>	Test	Norm	Port	Frequency	Limits	Radiated emissions	IEC55016	Case	30MHz...230MHz	40dB(µV/m) Qpk at 10m	230MHz...1GHz	47dB(µV/m) Qpk at 10m	1...3GHz	Do not apply	Conducted emissions	IEC55016	Input	3...6GHz	Internal freq. < 108MHz	150kHz...500kHz	79dB(µV) Qpk, 66dB(µV) Av				500kHz...30MHz	79dB(µV) Qpk, 60dB(µV) Av																																				
		Test	Norm	Port	Frequency	Limits																																																										
		Radiated emissions	IEC55016	Case	30MHz...230MHz	40dB(µV/m) Qpk at 10m																																																										
					230MHz...1GHz	47dB(µV/m) Qpk at 10m																																																										
					1...3GHz	Do not apply																																																										
		Conducted emissions	IEC55016	Input	3...6GHz	Internal freq. < 108MHz																																																										
					150kHz...500kHz	79dB(µV) Qpk, 66dB(µV) Av																																																										
					500kHz...30MHz	79dB(µV) Qpk, 60dB(µV) Av																																																										
		<table border="1"> <thead> <tr> <th>Test</th> <th>Norm</th> <th>Port</th> <th>Severity</th> <th>Conditions</th> <th>P</th> </tr> </thead> <tbody> <tr> <td rowspan="2">Electrostatic discharge</td> <td rowspan="2">IEC61000-4-2</td> <td rowspan="2">Case</td> <td>±8kV</td> <td>Air (isolated parts)</td> <td rowspan="2">B</td> </tr> <tr> <td>±8kV</td> <td>Contact (conductive parts)</td> </tr> <tr> <td rowspan="3">Radiated high-frequency</td> <td rowspan="3">IEC61000-4-3</td> <td rowspan="3">X/Y/Z Axis</td> <td>20V/m</td> <td>0.08...1.0GHz M. 80% 1kHz</td> <td rowspan="3">A</td> </tr> <tr> <td>10V/m</td> <td>1.4...2.1GHz M. 80% 1kHz</td> </tr> <tr> <td>5V/m</td> <td>2.1...2.5GHz M. 80% 1kHz</td> </tr> <tr> <td rowspan="4">Fast transients</td> <td rowspan="4">IEC61000-4-4</td> <td>Input</td> <td>±2kV</td> <td rowspan="4">Tr/Th: 5/50 ns</td> <td rowspan="4">A</td> </tr> <tr> <td>Output</td> <td>±2kV</td> </tr> <tr> <td>Signal</td> <td>±2kV</td> </tr> <tr> <td>PE</td> <td>±1kV</td> </tr> <tr> <td rowspan="2">Surge</td> <td rowspan="2">IEC61000-4-5</td> <td>Input L to L</td> <td>±1kV</td> <td rowspan="2">Tr/Th: 1.2/50µs</td> <td rowspan="2">B</td> </tr> <tr> <td>Input L to PE</td> <td>±2kV</td> </tr> <tr> <td rowspan="4">Conducted RF</td> <td rowspan="4">IEC61000-4-6</td> <td>Input</td> <td>10V</td> <td rowspan="4">0.15...80MHz M. 80% 1kHz</td> <td rowspan="4">A</td> </tr> <tr> <td>Output</td> <td>10V</td> </tr> <tr> <td>Signal</td> <td>10V</td> </tr> <tr> <td>PE</td> <td>10V</td> </tr> <tr> <td>Magnetic field</td> <td>IEC61000-4-8</td> <td>X/Y/Z Axis</td> <td>300A/m</td> <td>0Hz, 16.7Hz, 50/60Hz</td> <td>A</td> </tr> </tbody> </table>	Test	Norm	Port	Severity	Conditions	P	Electrostatic discharge	IEC61000-4-2	Case	±8kV	Air (isolated parts)	B	±8kV	Contact (conductive parts)	Radiated high-frequency	IEC61000-4-3	X/Y/Z Axis	20V/m	0.08...1.0GHz M. 80% 1kHz	A	10V/m	1.4...2.1GHz M. 80% 1kHz	5V/m	2.1...2.5GHz M. 80% 1kHz	Fast transients	IEC61000-4-4	Input	±2kV	Tr/Th: 5/50 ns	A	Output	±2kV	Signal	±2kV	PE	±1kV	Surge	IEC61000-4-5	Input L to L	±1kV	Tr/Th: 1.2/50µs	B	Input L to PE	±2kV	Conducted RF	IEC61000-4-6	Input	10V	0.15...80MHz M. 80% 1kHz	A	Output	10V	Signal	10V	PE	10V	Magnetic field	IEC61000-4-8	X/Y/Z Axis	300A/m	0Hz, 16.7Hz, 50/60Hz	A
		Test	Norm	Port	Severity	Conditions	P																																																									
Electrostatic discharge	IEC61000-4-2	Case	±8kV	Air (isolated parts)	B																																																											
			±8kV	Contact (conductive parts)																																																												
Radiated high-frequency	IEC61000-4-3	X/Y/Z Axis	20V/m	0.08...1.0GHz M. 80% 1kHz	A																																																											
			10V/m	1.4...2.1GHz M. 80% 1kHz																																																												
			5V/m	2.1...2.5GHz M. 80% 1kHz																																																												
Fast transients	IEC61000-4-4	Input	±2kV	Tr/Th: 5/50 ns	A																																																											
		Output	±2kV																																																													
		Signal	±2kV																																																													
		PE	±1kV																																																													
Surge	IEC61000-4-5	Input L to L	±1kV	Tr/Th: 1.2/50µs	B																																																											
		Input L to PE	±2kV																																																													
Conducted RF	IEC61000-4-6	Input	10V	0.15...80MHz M. 80% 1kHz	A																																																											
		Output	10V																																																													
		Signal	10V																																																													
		PE	10V																																																													
Magnetic field	IEC61000-4-8	X/Y/Z Axis	300A/m	0Hz, 16.7Hz, 50/60Hz	A																																																											
		P= Performance criteria, L= Line, PE= Protective Earth																																																														
4.3.7	Relative humidity	Up to 95%																																																														
5.1.1.2	DC power supply range	From 0.70 to 1.25 Un continuous																																																														
5.1.1.3	Temporary DC power supply fluctuation	From 0.60 to 1.40 Un 0.1s From 1.25 to 1.40 Un 1s without damage																																																														
5.1.1.4	Interruptions of voltage supply	Class S1 (without interruptions)																																																														
5.1.1.6	Input ripple factor	10% peak to peak with a DC Ripple Factor of 5 %																																																														
5.1.3	Supply change-over	0,6 Un duration 100 ms (without interruptions). Performance criterion A																																																														
7.2.7	Input reverse polarity protection	By fuse																																																														
10.7	Protective coating for PCB assemblies	Class PC2																																																														
13.3	Tests list	<ul style="list-style-type: none"> 1 Visual Inspection 2 Performance test 3 Power supply test 4 Insulation test 5 Low temperature storage test 6 Low temperature start-up test 7 Dry heat test 8 Cyclic damp heat test 9 Salt mist test 10 Enclosure protection test (IP code) 11 EMC test 12 Shocks and vibrations test 13 Equipment stress screening test 14 Rapid Temperature variation test 																																																														
		<ul style="list-style-type: none"> Routine Routine Routine Routine - Type Type Type - - Type Type Routine: 24h at 40°C and load 100% Type 																																																														

