

ODX-1300

1300VA DC/AC INVERTER

GENERAL FEATURES:

- Sine wave output voltage
- Suitable for motors control
- Adjustable output voltage
- High input-output isolation 3000Vrms
- Remote control via RS232
- Alarm by isolated relay contacts
- Remote ON/OFF opto-coupled
- According to the standard EN50155
- Fire and smoke: EN45545-2 approved



	24Vdc 16.8 ... 30V	72Vdc 50.4 ... 90V	110Vdc 77 ... 138V
250Vac	ODX-1300-7442 1300 VA	ODX-1300-7445 1300 VA	ODX-1300-7447 1300 VA
400Vac	ODX-1300-7452 1300 VA	ODX-1300-7455 1300 VA	ODX-1300-7457 1300 VA



INPUT

Input voltage range	-30, +25% Vin nom
Maximum input ripple	5% Vin nom (Vrms, 100Hz)
Inrush current	<25A
Polarity protection	By diode

OUTPUT

Nominal output voltage (Von)	See table (ordering codes)
Output voltage range	150 ... 250V (models of 250V output) via RS-232 200 ... 400V (models of 400V output) via RS-232
Output frequency range	5...60Hz via RS-232
Load regulation	< 4%
Line regulation	< 2% Vin -25% ... +25%, < 10% Vin -30% ... +30%
Output wave distortion THD	< 3% (average of 16 samples)
Output HF ripple	< 2.5%

ENVIRONMENTAL

Storage temperature	-25 ... 85°C
Operating temperature:	
Full load	-25 ... 55°C (EN50155 OT1)
62.5% load	-25 ... 70°C (EN50155 OT3)
25% load	-25 ... 85°C (EN50155 OT5)
Relative humidity without condensation	5 ... 95%
Cooling	Controlled internal fan
MTBF (MIL-HDBK-217-E; G _b , 25°C)	100.000 h

EMC

Immunity according	EN61000-6-2, EN50121-3-2
Emissions according	EN61000-6-4, EN50121-3-2

SAFETY

Dielectric strength: Input /output	3000 Vrms / 50Hz / 1min
Dielectric strength: Output / ground	1500 Vrms / 50Hz / 1min
Dielectric strength: Input / ground	1500 Vrms / 50Hz / 1min
Safety according to	EN60950-1, EN62368-1
Fire and smoke	EN45545-2

MECHANICAL

Weight	<3200 g
--------	---------

PROTECTIONS

Against overloads and short-circuits	Shutdown with auto-recovery (see working parameters)
Against over-temperature	Shutdown with auto-recovery

CONTROL

Output alarm	Open when alarm. Maximum rating: 0.16A at 160Vdc
Remote OFF input	Off applying 15...143Vdc, Impedance>18kΩ



ORDERING CODES

Model	Input voltage DC [V]	Input voltage range [V]	Output voltage AC [V]	Output current [A]	Active output power [W]	Appar. output power [VA]	Output peakcurrent 10ms (I _{opk}) [A]	Efficien. [%]	No load input current [A]	Size
ODX-1300-7442	24	16.8 - 30	250	3.10	1100	1300	6.6	89	<1.58	2
ODX-1300-7445	72	50.4 - 90	250	3.10	1100	1300	6.6	90	< 0.52	1
ODX-1300-7447	110	77 - 138	250	3.10	1100	1300	6.6	90	< 0.34	1
ODX-1300-7452	24	16.8 - 30	400	1.88	1100	1300	3.4	89	<1.58	2
ODX-1300-7455	72	50.4 - 90	400	1.88	1100	1300	3.4	90	< 0.52	1
ODX-1300-7457	110	77 - 138	400	1.88	1100	1300	3.4	91	< 0.34	1



BLOCKS DIAGRAM

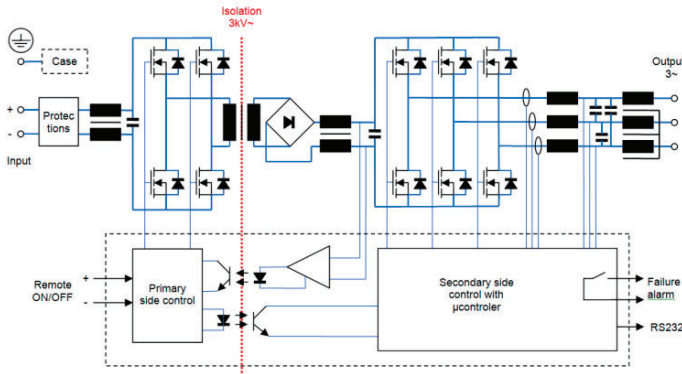

RS232 Monitoring	RS232 Settings
Output voltage	On / Off
Internal temperature	Output voltage
Output frequency	Output frequency
Inverter state	Reset
Model number	
Firmware version	

CONNECTIONS

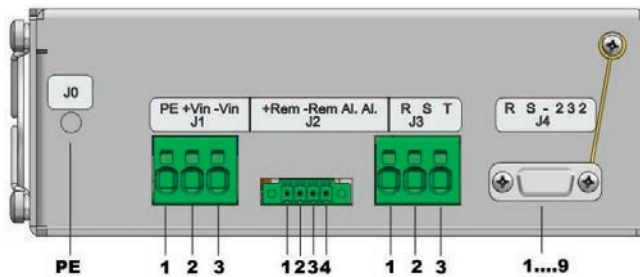

J0	Case PE	Threaded shank M6
J1-1	Protective Earth	Cable 1.5...16mm ²
J1-2	+Input	
J1-3	-Input	
J2-1	+Remote off	Phoenix Contact MC1.5/4-ST-3.81 Note (1)
J2-2	-Remote off	
J2-3	Alarm	
J2-4	Alarm	
J3-1	R Output	Cable 0.75...4mm ²
J3-2	S Output	
J3-3	T Output	
J4-2	RS232 Rx	SUB DB9
J4-3	RS232 Tx	
J4-5	RS232 GND	

POWER DERATING vs AMBIENT TEMP.

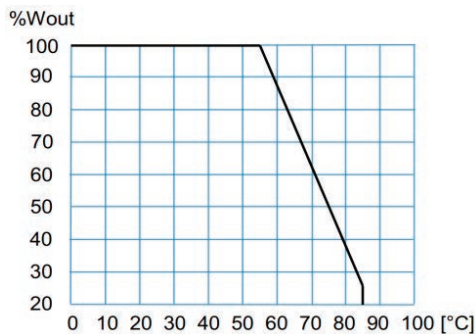

DESCRIPTION

The ODX-1300 consists of three phase sine-wave DC-AC inverters with galvanic isolation between input and output.

The unit allows:

- Start-up motors by means of a soft start. In the start-up, the output voltage and frequency rise linearly from 0V to set voltage and from 5Hz to set frequency. The start-up ramp slope may be changed via RS-232 port
- Set the rotation speed of a motor according to the appropriate Voltage/Frequency ratio.
- Monitoring the status of the input and output.
- Set and monitor parameters via RS-232.

The ODX-1300 has a maximum output current protection. This protects the semiconductors even when an output short-circuit occurs. It also features a disable function for input under-voltage.

INSTALLATION

- The unit has 4 threaded holes for the fixation on a mounting surface.
- The unit has internal fans. For an appropriate cooling, the air input and output should be free of elements that cause and an air flow reduction (minimum recommended distance to other objects 50mm).
- Make connections as shown in the figure.

For safety reasons, the following requirements must be met:

- Provide the equipment with some kind of protective enclosure that complies with the electrical safety directives in effect within the country where the equipment is installed.
- Include an input fuse with a rating immediately higher than the maximum input current.
- Use cables of adequate cross-section to connect inputs and outputs. The following table lists the maximum currents and the minimum cross-sections for the cables used for each power connection.

	Input 24V	Input 72V	Input 110V	Output 250V	Output 400V
Current	70A	24.4A	16 A	3.1A	1.88A
Cable cross section	16 m ²	2.5 mm ²	1.5 mm ²	0.75 mm ²	0.75 mm ²



RS232 communication port

It is possible to control and monitor the unit via RS232 by means of an application tool named PAM. This application is free and can be downloaded from the Premium web site

Also it is possible to control and monitor the unit directly using the protocol showed in table:

Protocol configuration: ASCII code, 9600 bauds, parity none, 8 bits, 1bit stop

Header	Function	Parameter	Returns	Description	
P	L	U	PTU###.■	Output voltage in Volts RMS	
		T	PTT###.■	Internal temperature in °C	
		F	PTF###.■	Output frequency in Hz	
		S	PTS###.■	Inverter status 999.9 → Enabled 000.0 → Disabled 111.1 → Inverter blocked by overload or short-circuit	
		M	PTM####	Model number	
		R	PTR####	Firmware version	
		Other character	PTE	Command not supported	
	G	3	###.■	OK / ERR	Changes the inverter status 999.9 → Enabled 000.0 → Disabled
		4	###.■	OK / ERR	Set the output voltage in Volts RMS 150.0 ≤ ###.■ ≤ 250.0 (models of 250V output) 200.0 ≤ ###.■ ≤ 400.0 (models of 400V output)
		6	###.■	OK / ERR	Changes the output frequency in Hz (output must be stopped) 005.0 ≤ ###.■ ≤ 075.0 Factory preconfigured → 50 Hz
		8	###.■	OK / ERR	111.1 → Reset the inverter
		B	###.■	OK / ERR	Changes the logic of the 'Remote OFF input' 222.2 → Inverter On applying 15...143Vdc on 'Remote OFF input' 111.1 → Inverter Off applying 15...143Vdc on 'Remote OFF input'
		O	###.■	OK / ERR	Set the initial frequency in the start-up (Fi) (output must be stopped) 005.0 ≤ ###.■ ≤ 075.0 Factory preconfigured → 16Hz
		P	###.■	OK / ERR	Set the ramp-up in increment of "N" cycles per Hz in mode V/F, frequency changes or start-up (Note-1) 001.0 ≤ ###.■ ≤ 100.0

Note: **OK** (Data accepted) / **ERR** (Data not valid for the current parameter)



Note 1:

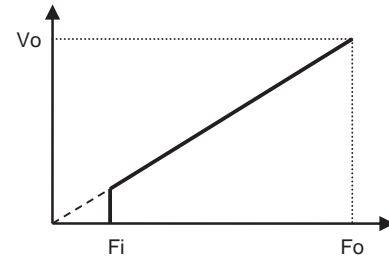
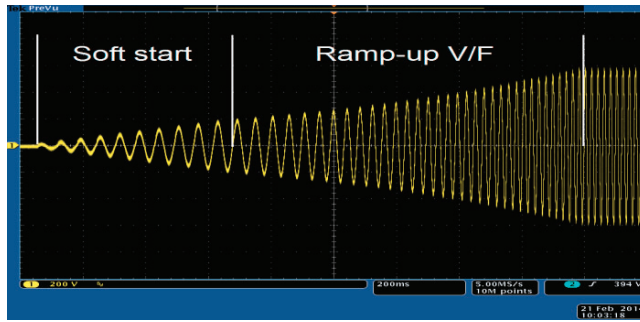

Mode V/F curve

Example for N=1: start-up time = N x 1.7s for changes from 16Hz to 50Hz

DEFAULT WORKING PARAMETERS

Thermal protection		7442 ... 7457			
Internal shutdown temperature		87			°C
Internal restart temperature		82			°C
Internal temperature of fan start-up		45			°C
Input voltage parameters		74X2	74X5	74X7	
<u>Low input voltage timed shutdown (t)</u> (Input alarm)		16.8	50.4	77.0	Vdc
Low input voltage instantaneous shutdown		14.4	43.2	66.0	Vdc
Time to shutdown (t)		500			ms
Output voltage parameters		744X	745X		
<u>Output voltage</u>		250	400		Vac
Output under-voltage shutdown		< 85% of setting 1000ms			
Warning voltage (output alarm)		< 90% of setting 200ms			
<u>Initial start-up frequency</u>		5			Hz
Soft start duration		10 cycles			
<u>Ramp-up V/F</u>		1 Hz/cycle			
Output current parameters		744X	745X		
<u>Maximum continuous output current</u>		3.10	1.88		A
Time between restart attempts		4000			ms
Number of attempts of consecutive overload		3			
Working failures and reset		7442 ... 7457			
Lock for continuous overload or internal failure		Unlimited time			
Reset time by input disconnection		>2			min

Configurable parameters underlined



DIMENSIONS

SIZE-1

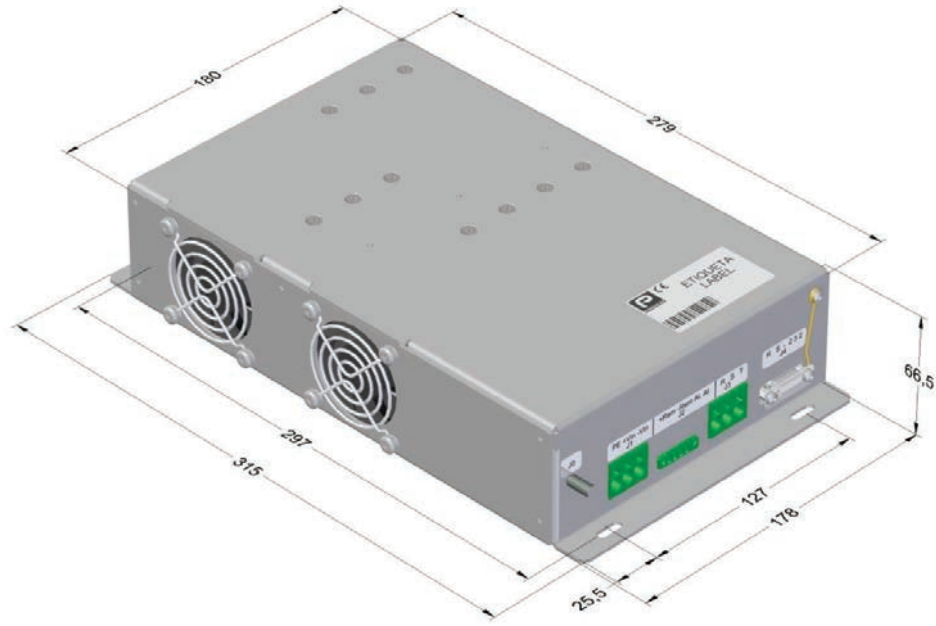

SIZE-2

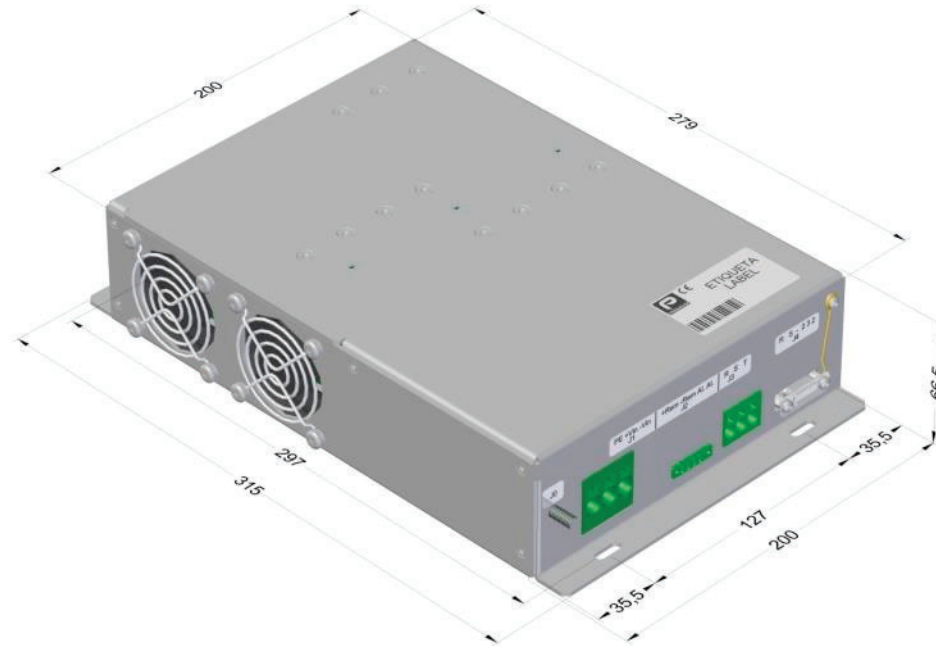



CE EU DECLARATION OF CONFORMITY

The undersigned, representing the following:

Manufacturer: PREMIUM, S. A.,
Address: C/ DolorsAleu 19-21, 08908 L'Hospitalet de Llobregat, SPAIN

herewith declares that the product:

Type: DC/AC INVERTER
Models: **ODX-1300-7442 ... 7457**

is in conformity with the provisions of the following EU directive(s):

2014/35/EU	Low voltage
2014/30/EU	Electromagnetic compatibility
2011/65/EU	Restriction of the use of certain hazardous substances in electrical and electronic equipment (RoHS)

and that standards and/or technical specifications referenced overleaf have been applied:

EN 60950-1: 2005	Safety. Information technology equipment
EN 62368-1: 2014	Safety. Audio/video, information and communication technology equipment
EN 61000-6-3: 2007	Generic emission standard
EN 61000-6-2: 2005	Generic immunity standard
EN 50155: 2017*	Railway applications. Electronic equipment used on rolling stock material
EN 50121-3-2: 2016*	Railway applications. EMC Rolling stock equipment

* Optional, See annexe

CE marking year: **2017**

Notes:

For the fulfilment of this declaration the product must be used only for the aim that has been conceived, considering the limitations established in the instructions manual or datasheet.

L'Hospitalet de Llobregat, 04-11-2019

Jordi Gazo
Chief Executive Officer

PREMIUM S.A. is an ISO9001 and ISO14001
certified company by **Bureau Veritas**



ANNEXE

Applicable values for the different sections of the norm EN50155: 2017

4.3.1	Working altitude	Up to 2000m																																																																					
4.3.2	Ambient temperature	Class OT1 (-25 to 55°C): load < 100% Class OT3 (-25 to 70°C): load < 62.5% Class OT5 (-25 to 85°C): load < 25%																																																																					
4.3.3	Switch-on extended operating temp.	ST1																																																																					
4.3.4	Rapid temperature variations	H1																																																																					
4.3.5	Shocks and vibrations	According EN61373:2010 Category 1 class B																																																																					
4.3.6	EMC Electromagnetic Compatibility EN50121-3-2:2016	<table border="1"> <thead> <tr> <th>Test</th> <th>Norm</th> <th>Port</th> <th>Frequency</th> <th>Limits</th> </tr> </thead> <tbody> <tr> <td rowspan="3">Radiated emissions</td> <td rowspan="3">IEC55016</td> <td rowspan="3">Case</td> <td>30MHz...230MHz</td> <td>40dB(µV/m) Qpk at 10m</td> </tr> <tr> <td>230MHz...1GHz</td> <td>47dB(µV/m) Qpk at 10m</td> </tr> <tr> <td>1...3GHz 3...6GHz</td> <td>Do not apply Internal freq. < 108MHz</td> </tr> <tr> <td rowspan="2">Conducted emissions</td> <td rowspan="2">IEC55016</td> <td rowspan="2">Input</td> <td>150kHz...500kHz</td> <td>99dB(µV) Qpk</td> </tr> <tr> <td>500kHz...30MHz</td> <td>93dB(µV) Qpk</td> </tr> </tbody> </table>				Test	Norm	Port	Frequency	Limits	Radiated emissions	IEC55016	Case	30MHz...230MHz	40dB(µV/m) Qpk at 10m	230MHz...1GHz	47dB(µV/m) Qpk at 10m	1...3GHz 3...6GHz	Do not apply Internal freq. < 108MHz	Conducted emissions	IEC55016	Input	150kHz...500kHz	99dB(µV) Qpk	500kHz...30MHz	93dB(µV) Qpk																																													
		Test	Norm	Port	Frequency	Limits																																																																	
		Radiated emissions	IEC55016	Case	30MHz...230MHz	40dB(µV/m) Qpk at 10m																																																																	
					230MHz...1GHz	47dB(µV/m) Qpk at 10m																																																																	
					1...3GHz 3...6GHz	Do not apply Internal freq. < 108MHz																																																																	
		Conducted emissions	IEC55016	Input	150kHz...500kHz	99dB(µV) Qpk																																																																	
					500kHz...30MHz	93dB(µV) Qpk																																																																	
		<table border="1"> <thead> <tr> <th>Test</th> <th>Norm</th> <th>Port</th> <th>Severity</th> <th>Conditions</th> <th>P</th> </tr> </thead> <tbody> <tr> <td rowspan="2">Electrostatic discharge</td> <td rowspan="2">IEC61000-4-2</td> <td rowspan="2">Case</td> <td>±8kV</td> <td>Air (isolated parts)</td> <td rowspan="2">B</td> </tr> <tr> <td>±8kV</td> <td>Contact (conductive parts)</td> </tr> <tr> <td rowspan="4">Radiated high-frequency</td> <td rowspan="4">IEC61000-4-3</td> <td rowspan="4">X/Y/Z Axis</td> <td>20V/m</td> <td>0.08...1.0GHz M. 80% 1kHz</td> <td rowspan="4">A</td> </tr> <tr> <td>10V/m</td> <td>1.4...2.1GHz M. 80% 1kHz</td> </tr> <tr> <td>5V/m</td> <td>2.1...2.5GHz M. 80% 1kHz</td> </tr> <tr> <td>3V/m</td> <td>5.1...6Ghz M. 80% 1kHz</td> </tr> <tr> <td rowspan="4">Fast transients</td> <td rowspan="4">IEC61000-4-4</td> <td>Input</td> <td>±2kV</td> <td rowspan="4">Tr/Th: 5/50 ns</td> <td rowspan="4">A</td> </tr> <tr> <td>Output</td> <td>±2kV</td> </tr> <tr> <td>Signal</td> <td>±2kV</td> </tr> <tr> <td>PE</td> <td>±1kV</td> </tr> <tr> <td rowspan="2">Surge</td> <td rowspan="2">IEC61000-4-5</td> <td>Input L to L</td> <td>±1kV</td> <td rowspan="2">Tr/Th: 1.2/50µs</td> <td rowspan="2">B</td> </tr> <tr> <td>Input L to PE</td> <td>±2kV</td> </tr> <tr> <td rowspan="4">Conducted RF</td> <td rowspan="4">IEC61000-4-6</td> <td>Input</td> <td>10V</td> <td rowspan="4">0.15...80MHz M. 80% 1kHz</td> <td rowspan="4">A</td> </tr> <tr> <td>Output</td> <td>10V</td> </tr> <tr> <td>Signal</td> <td>10V</td> </tr> <tr> <td>PE</td> <td>10V</td> </tr> <tr> <td>Magnetic field</td> <td>IEC61000-4-8</td> <td>X/Y/Z Axis</td> <td>300A/m</td> <td>0Hz, 16.7Hz, 50/60Hz</td> <td>A</td> </tr> </tbody> </table>						Test	Norm	Port	Severity	Conditions	P	Electrostatic discharge	IEC61000-4-2	Case	±8kV	Air (isolated parts)	B	±8kV	Contact (conductive parts)	Radiated high-frequency	IEC61000-4-3	X/Y/Z Axis	20V/m	0.08...1.0GHz M. 80% 1kHz	A	10V/m	1.4...2.1GHz M. 80% 1kHz	5V/m	2.1...2.5GHz M. 80% 1kHz	3V/m	5.1...6Ghz M. 80% 1kHz	Fast transients	IEC61000-4-4	Input	±2kV	Tr/Th: 5/50 ns	A	Output	±2kV	Signal	±2kV	PE	±1kV	Surge	IEC61000-4-5	Input L to L	±1kV	Tr/Th: 1.2/50µs	B	Input L to PE	±2kV	Conducted RF	IEC61000-4-6	Input	10V	0.15...80MHz M. 80% 1kHz	A	Output	10V	Signal	10V	PE	10V	Magnetic field	IEC61000-4-8	X/Y/Z Axis	300A/m	0Hz, 16.7Hz, 50/60Hz	A
		Test	Norm	Port	Severity	Conditions	P																																																																
		Electrostatic discharge	IEC61000-4-2	Case	±8kV	Air (isolated parts)	B																																																																
					±8kV	Contact (conductive parts)																																																																	
		Radiated high-frequency	IEC61000-4-3	X/Y/Z Axis	20V/m	0.08...1.0GHz M. 80% 1kHz	A																																																																
					10V/m	1.4...2.1GHz M. 80% 1kHz																																																																	
					5V/m	2.1...2.5GHz M. 80% 1kHz																																																																	
3V/m	5.1...6Ghz M. 80% 1kHz																																																																						
Fast transients	IEC61000-4-4	Input	±2kV	Tr/Th: 5/50 ns	A																																																																		
		Output	±2kV																																																																				
		Signal	±2kV																																																																				
		PE	±1kV																																																																				
Surge	IEC61000-4-5	Input L to L	±1kV	Tr/Th: 1.2/50µs	B																																																																		
		Input L to PE	±2kV																																																																				
Conducted RF	IEC61000-4-6	Input	10V	0.15...80MHz M. 80% 1kHz	A																																																																		
		Output	10V																																																																				
		Signal	10V																																																																				
		PE	10V																																																																				
Magnetic field	IEC61000-4-8	X/Y/Z Axis	300A/m	0Hz, 16.7Hz, 50/60Hz	A																																																																		
P= Performance criteria, L= Line, PE= Protective Earth																																																																							
4.3.7	Relative humidity	Up to 95%																																																																					
5.1.1.2	DC power supply range	From 0.70 to 1.25 Un continuous																																																																					
5.1.1.3	Temporary DC power supply fluctuation	From 0.60 to 1.40 Un 0.1s																																																																					
5.1.1.4	Interruptions of voltage supply	Class S1 (without interruptions)																																																																					
5.1.1.6	Input ripple factor	10% peak to peak with a DC Ripple Factor of 5 %																																																																					
5.1.3	Supply change-over	0.6 Un duration 100 ms (without interruptions). Performance criterion A																																																																					
7.2.7	Input reverse polarity protection	By external fuse																																																																					
10.7	Protective coating for PCB assemblies	Class PC2																																																																					
13.3	Tests list	1 Visual Inspection 2 Performance test 3 Power supply test 4 Insulation test 5 Low temperature storage test 6 Low temperature start-up test 7 Dry heat test 8 Cyclic damp heat test 9 Salt mist test 10 Enclosure protection test (IP code) 11 EMC test 12 Shocks and vibrations test 13 Equipment stress screening test 14 Rapid Temperature variation test	Routine Routine Routine Routine - Type Type Type - - - Type Type Routine: 24h at 40°C and load 100% -																																																																				

